

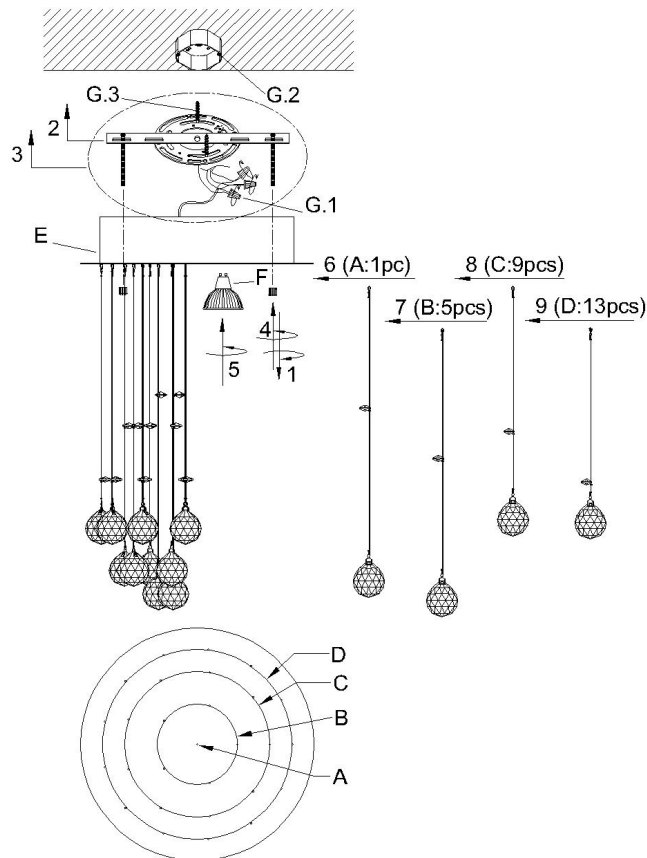







## 56028, Pollow Ceiling Lamp

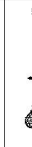

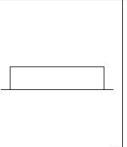
PARTS LIST/Liste des pièces					
A	B	C	D	E	F
					
x1	x5	x9	x13	x1	x3
					G.1.  x3
					G.2.  x2
					G.3.  x2

### Assembly Instructions:

1. Before assembling, turn off the main power source.
2. Use three (3) GU10, Halogen Max. 25W light bulbs.
3. To avoid scratches and damages, do not use hard or sharp tools to assemble the lamp.
4. For their safety, keep children away from the electric parts of this lamp.

If the external wire or cable becomes damaged, only the manufacturer, service agent or qualified individual should make the repairs in order to avoid hazard.

### Instructions d'Assemblage:

1. Avant l'assemblage, couper la source d'alimentation du courant électrique.
2. Utiliser trois ampoules (3) GU10, Halogène Max.25W.
3. Pour éviter de faire des égratignures et dommages, ne pas se servir d'outils durs ou pointus pour l'assemblage de cette lampe.
4. Pour leur protection, tenir les enfants loin des conduits électriques.

Si un fil ou câble extérieur se brise, faire réparer seulement par le fabricant, son agent ou une personne qualifiée afin d'éviter tout danger.

For missing parts or damaged parts, please call : USA : 1-866-798-6663 Canada : (514) 382-6661